

# EPSION MARATHON 200

## USER GUIDE

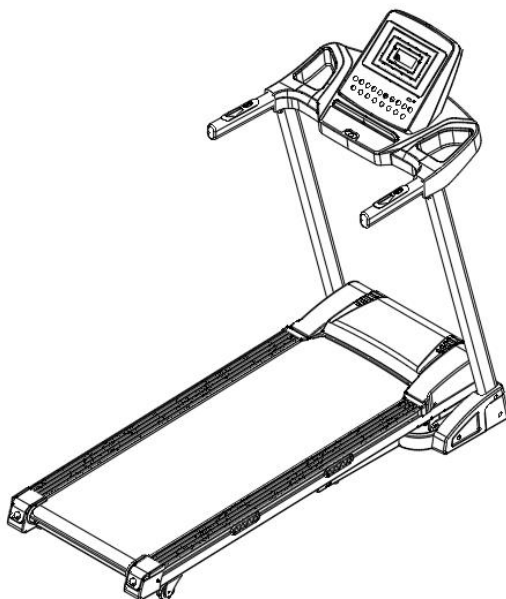

**Please read this manual carefully before using this product and store it safely**

# Directory

Page number	Content
1	Directory
2	Safety instruction
3	Packaging Details
4	Assembly instructions
6	Instructions for electric control
7	System operation guide
11	Maintenance guidelines
13	General errors and troubleshooting
15	Maintenance clauses
16	Warm-up exercise

## Guidance on safe use

This machine is designed and manufactured to consider many safety issues, to ensure your safety, before using this machine, be sure to read all the contents of this manual, for safety. We do not bear the consequences of any abnormal operation.





### **Danger**

Do not hold pulse devices and other wireless pulse devices at the same time, otherwise it will cause electrical interference.

## Warning

1. Before using this machine, make sure the machine is fully grounded to avoid accidents and hazards
2. When running, please clamp the safety lock (red) clip in the appropriate position clothes to facilitate the emergency to pull off the safety lock and stop the machine to ensure safety.
3. a、consult your doctor before exercise.  
b、wear appropriate sports clothes for exercise.  
c、the room to keep clean and neat, to avoid electrostatic adsorption in the treadmill, resulting in machine operating errors.  
d、must not exceed 120 kg. weight
4. This product is for one person when driving. Do not let children or pets play nearby to avoid accidents.
5. The minimum distance requirement (distance from wall and furniture) is not less than 100 cm for front and side, and 200 cm. for behind.
6. If the power cord is damaged, do not use this machine.
- 7.If the machine is damaged and broken, do not use the machine and contact immediately the local dealer for maintenance.
8. Do not touch any moving parts by hand, and do not push in or plug any objects into the machine.
- 9.This machine is applicable for household indoor use, not for outdoor and gym use.
10. Place the machine on a clean and flat ground, keep the ventilation condition of the machine in good condition, make sure there are no sharp objects nearby, do not use it near the water source and the heat source.
11. Use handrails when walking up and down the machine, when the walking machine is not complete stable, do not get off the machine. If you need an emergency jump, you must disconnect the fuse lock: the treadmill stops immediately.
12. All parts of the machine must be properly installed.
13. After using the treadmill, please turn off the power and pull out the plug in time.

## Packaging Details

Series number	Components	
1	Main frame	
2	Electronic watch bezel	
3	Side protection cover	
4	User manual	
5	Screw package	

## Accessories

Series number	Components	Quantity
A	Security key	1 pc
B	6 mm hex key	1 pc
C	Lubricating oil	1 bottle
D	M8 * 16 half-round hex screws	8 pcs
E	M8 flat washer	10 pcs
F	M8*40 hex screw with half-round head	2 pcs
G	Wrench 13-14 (2.5MM)	1 pc
H	M8*45 Hex bolts with half round head	4 pcs
I	M8 hexagon nut	4 pcs
J	ST4.0*16 Cross Washer Head Self-tapping and self-drilling screws	6 pcs
K	ST4.0*16 self-tapping screws with cross washer	1 pc
L	M 6 flat washer	1 pc
M	Phillips screwdriver	1 bit

# Assembly instructions

Step 1: Lift out the main frame and the electronic meter frame from the carton and open the bundles of the frame.

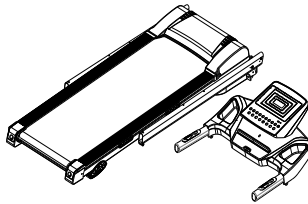

Step 2: Pull up the column in the direction of the arrow, use F # M8\*40 inner circle head hex screw and D#M8\*16 inner half circle head hex screw, and attach it to the sub frame.

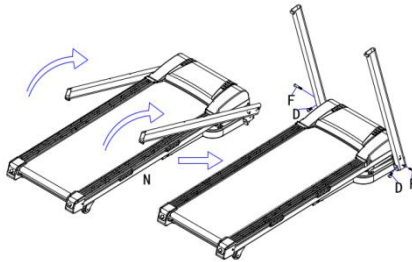

Step 3 : Attach the electronic clock bezel to the column in the direction of the arrow, then use E#M8 flat washers (4pcs), D#M8\*16 (2pcs), H# M8\*45 (2pcs), I#M8 hexagonal tension nuts (2pcs) to attach the electronic watch bezel to the pillar, turn the electronic watch movement and case in the direction of the arrow as shown and tighten the K#ST4\*16 self-tapping screws with cross washers .

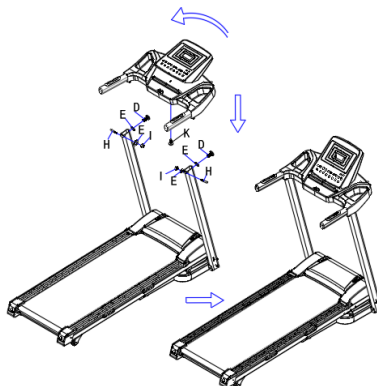

Step 4: Attach the side cover to the pillar and base frame with the J#ST4\*16 screws as shown in the figure

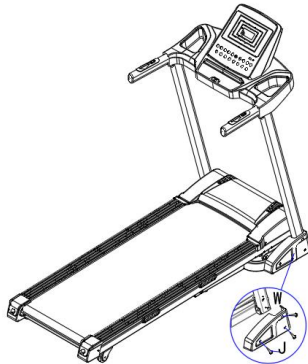

Step 5: At this time, the electronic clock on the lamp lights up, press the start button the machine can be run!

**(Note: the safety lock must be placed on the yellow sticker position in the center of the meter before the treadmill can start normally; if the electronic clock window shows "E07", the security the lock is not positioned or not in place.)**

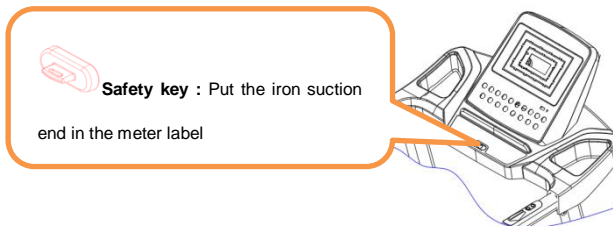

Emergency stop function: after the safety lock is pulled off, the power supply is cut off and the weak part maintains the power supply. The operation is not controlled by software.

For your safety be sure to use the safety lock when training!

Note: after confirming that all screws are installed in accordance with the above requirements, lock all the screws evenly and check that there are no omissions before you can connect to the power supply.

Step 7: product folding: when you need to wear or not use this product for a long time, please fold it up as shown below: at the rear end of the running platform, slowly lift the start

the platform in the direction of the arrow until the air spring makes a "clipping" sound.

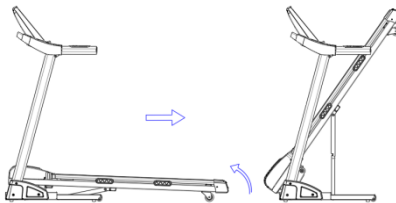

Product expansion: with the foot as follows light kick air spring card position, you can expand the product.

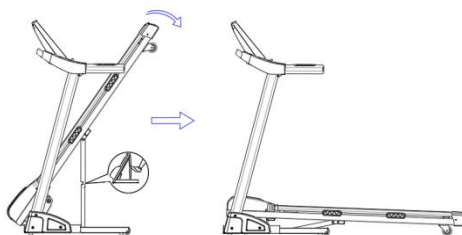

## Operating instructions for electronic control

### Using

1. Insert the plug into the socket and switch (red) on the machine. Enter manual mode: After the electronic power meter, enter the initial standby mode, then press the start button, enter manual mode .

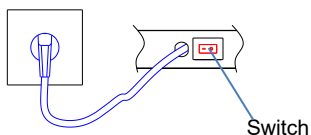

2. Security key Introduction:

The machine can only work when you put the safety key in the intended position. Make sure the other end of the security key is clipped to your clothing. This way you can pull the safe key for the sudden stop of the machine during the dangerous condition. Then you won't get hurt. If you need to use the machine again, you can put the safety key back.

## System Operation Guide

3. The appearance of the electronic clock



#### **4. Start**

Start normally after 3 second countdown

#### **5. Programs**

3 manual programs, 12 automatic programs.

#### **6. Security key function**

Disengage the safety lock and immediately show "E07" the treadmill to stop quickly and beep alarm sound appears, turn on the safety lock when the electronic clock full display 2 seconds, all data zero

#### **7. Key feature**

7.1 Start button, in the treadmill stop position, press the start button, speed display "1km", treadmill start. Stop button, in the treadmill running, press the stop button, all data is deleted, the treadmill stops back to manual mode, the treadmill stops. The handle contains the start key and the stop key.

##### **7.2 PROG KEY**

In standby mode, press this button to switch from manual mode to automatic mode P1—P12; manual mode is the system's default mode

##### **7.3 Mode buttons**

In standby mode, press this button to select 3 different inverted driving modes. Time countdown mode, distance countdown mode, calorie countdown mode; when selecting different modes, you can use the key to add and subtract the speed to set the relevant countdown value and press the "start" button to start the treadmill after setting.

##### **7.4 Speed reduction key**

It can be used to adjust the set value when setting the treadmill parameters. The treadmill can be used to adjust the speed, step / time and automatically increase or decrease when pressed for more than 2 seconds. The handle contains the speed addition and subtraction key.0.1 Km

##### **7.5 Incline Plus and Incline Keys**

Can be used to adjust the setting value when setting the parameters of the treadmill model. Once the treadmill has started, it can be used to adjust the incline, in increments of 1/step, which automatically and continuously increases or decreases when pressed for more than 2 seconds. These two buttons are



located on the handle.

### 7.6 speed shortcut

Adjust directly to the corresponding speed, 3KM, 6KM, 9KM, 12KM on the display control panel press speed shortcut 2

### 7.7 Inclined Hotkeys

Press the tilt shortcuts 3, 6, 9 and 12 on the display control panel to adjust directly to the appropriate height. 7 Display function

### 8.1 Speed display

Displays the speed value for the current run.

### 8.2 Time display

Running time in manual mode or countdown in mode and program.

### 8.3 Distance display

Displays the accumulated or reciprocal distance in manual and programmed mode.

### 8.4 Calorie display

Displays the accumulated number of calories during exercise in manual and program mode or countdown of calories running in mode.

### 8.5 Pulse display

The pulse value is displayed if a pulse signal is detected.

### 8.6 Lift display

Displays current rise value and pulse value if a pulse signal is detected.

## 9. Automation program

Each program segment is divided into 10 segments and the duration of each program segment is equally distributed. The following is a motion chart with 12 programs

Period Program		set time/10 = running time for each segment									
		1	2	3	4	5	6	7	8	9	10
P1	SPEED	3	3	8	5	5	6	3	4	4	3
P2	SPEED	3	3	4	4	5	6	5	8	8	4
P3	SPEED	2	4	8	8	4	4	5	2	3	2
P4	SPEED	3	3	5	4	2	6	5	4	3	3
P5	SPEED	3	8	2	4	5	5	2	5	5	4

P6	SPEED	2	8	5	4	4	3	2	3	3	3
P7	SPEED	2	4	5	8	5	8	5	3	2	2
P8	SPEED	2	4	4	4	5	6	5	3	8	2
P9	SPEED	2	4	5	5	8	5	8	3	3	2
P10	SPEED	2	5	5	5	3	2	5	2	4	3
P11	SPEED	2	5	8	3	5	3	2	5	3	2
P12	SPEED	2	3	5	8	4	8	3	8	5	3

PROG \ INCL.		set time/10 = run time for each slope segment									
		1	2	3	4	5	6	7	8	9	10
P1	INCL	0	3	3	3	4	4	4	1	1	0
P2	INCL	2	2	2	3	3	3	3	4	4	2
P3	INCL	3	5	4	4	3	4	4	3	4	2
P4	INCL	0	3	3	2	2	5	5	3	3	2
P5	INCL	3	5	3	4	2	3	4	2	3	2
P6	INCL	3	4	5	6	3	5	5	6	4	3
P7	INCL	0	3	3	3	4	4	4	1	1	0
P8	INCL	1	1	4	4	4	5	5	4	3	2
P9	INCL	3	5	3	4	2	3	4	2	3	2
P10	INCL	1	5	6	8	12	9	10	9	5	3
P11	INCL	3	5	6	8	6	5	8	7	5	2
P12	INCL	5	7	5	8	6	5	9	10	6	2

**10 Parameter setting in 3 modes**

10 .1 The countdown is initially set to 10:00 minutes, with an interval of 5:00-99: 59 minutes and a step of 1:00.

10 .2 The initial card is set to 50 kcal, the range is 20-990 kcal, step 10.

10 .3 The reverse distance is set to the initial distance, the setting range is 1.0-, step 1.0. 1.0 km 99.9 km

Cycling order is: manual, time, distance, calories.

### 1.1 Physical fitness test (FAT):

Press the PROG button to select FAT (Body Fat Calculator Program). The computer screen shows FAT. Press "Mode" key to select the parameter to be set (F1-Gender, F2-Age, F3-Height, F4--Weight), press "Speed+", "Speed--" to set these parameters. " Buttons to set these parameters. When the settings are finished, then press "Mode key" to switch the display to F5, hold the handheld pulser to enter the body mass test to see if your weight and height are proportional.

"Body Mass Index (FAT) is a measure of the relationship between a person's height and weight, not body proportions. FAT is suitable for all men and women and, together with other health indicators, provides a basis for adjusting one's weight. Ideally, FAT should be between 20 and 25; under 19 means underweight, between 25 and 29 is considered fat. (This data is for reference only and should not be considered as medical data.)

F1 Sex 01 Male 02 Female

F2 Age 10-----99

F3 Height 100----200

F4 Weight 20-----150

F5 FAT ≤19 Underweight

FAT = (20---25) Normal weight

FAT = (25---29) Overweight

FAT ≥30 Obesity

The standard value for calories is 30 kcal/km. The acceleration is 0.1 km/S, the deceleration is 0.1 km/S.

### 14. Other

When a countdown parameter is running, the display shows END ,0.5 second alarms every other seconds until the treadmill stops and then returns to manual mode. If you set a parameter, you can loop, for example, the time range is 5:00-99: 59. When you set it to 99:59. press the "+" button and return to 5:00 to cycle. Add and subtract with the "+" symbol. The reverse counting time, the reverse counting path, the reverse counting distance can only set one of them, run according to the last setting,

set the parameters countdown, others show forward counting. The default value for calories is 30 kcal/km. The acceleration is / S0.1 Km, and the deceleration is / S0.1 Km

## Maintenance guidelines

Proper maintenance can always keep your treadmill in top condition, incorrect maintenance can damage or shorten the life of the treadmill.

**Warning:** Be sure to disconnect the treadmill before cleaning or maintaining the product!

1. Regular dust removal to keep components clean,
2. After each use of the treadmill, wipe the clean instrument and other parts of the sweat and debris with a clean towel or cloth. Be careful not to splash water on the electricity components and under the timing belt.
3. Place your treadmill in a clean, dry environment, make sure the power is off and that the contact has been disconnected.
4. To facilitate movement, the treadmill is equipped with wheels. Be sure to disconnect power and fold the fuselage before moving.
5. Always check and lock all parts of the treadmill; parts of the damaged ring must be replaced immediately.
6. To better maintain and extend the life of the treadmill, it is recommended that you keep the treadmill for 10 minutes after 30 minutes of continuous use.
7. The running belt has been adjusted when it leaves the factory, but after use, the running the belt will be stretched and will deviate from the center position to cause damage to the friction lip and the backing. The running belt is forced to stretch during use. After some time, if you use the treadmill, you can adjust the tension of the treadmill to improve.

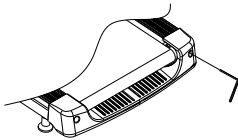

### A. Run the belt elastic adjustment

If the treadmill belt is too loose, insert the randomly presented hex key into the adjustment hole on the left foot of the treadmill, turn 1/4 turn clockwise, then turn 1/4 turn clockwise to the right foot. This can tension the timing belt, and the timing belt will not deviate from the center point. If

the running belt is too tight, adjust the left and right synchronization counterclockwise.

**Note:** the running belt cannot be adjusted too tightly. This will break the timing belt, increase the pressure from the front / rear roller, damage the roller bearing, produce abnormal noise or other problems, just adapting to the running belt without cord is the most suitable.

### B. Adjust treadmill alignment

When you use the treadmill, the pressure on the treadmill is unbalanced because the two feet are not the same when running, which results in the running belt deviating from the center. This deviation is normal, and when no one is running on the treadmill, it will automatically return to normal

center. If you can't get back to the center, you must run back to the center.

Run the treadmill without load, speed to sixth gear, observe the distance from the run belt on the left and right-side bars:

- if left, use a hex key to turn the left screw 1/4 turn clockwise.
- if to the right, use a hex key to turn the right screw 1/4 turn clockwise.
- if the running belt is still not in the center, repeat the above operation until it is adjusted to middle.

After adjusting the run to center, adjust the speed to sixth gear and observe the deviation of the running belt and the smooth running. If there is any discrepancy, repeat adjustment step.

Warning! Do not tighten the roller too tightly! This will cause permanent damage to the bearing!

#### 1. Lubricating oil

The treadmill is lubricated when it leaves the factory, but it is often tested for lubrication, which helps the treadmill to hold itself in the best way. The treadmill must be lubricated after one year or 100 hours of operation.

After 30 hours or 30 days of use, in the static state of the treadmill, pull up the running belt 13 from the side to touch the surface of the platform as far as possible, if you feel the lubricating oil, you do not need to add lubricating oil; If you touch the surface with a strong feeling of dryness, follow the following instructions for refueling. (Use lubricant without oil)

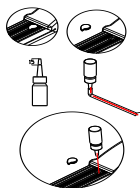

How to fill lubricating oil, follow the following way to use, open the left front side of the edge bar refueling decorative cover, with scissors or a knife to cut the lubricating oil bottle according to the size of the drawing, and then tap the bottom icon refueling. Pay attention to inserting the rod into the oil pipe on the platform.

# General errors and troubleshooting

## 1. Electronic display error code and exclusion

Error codes	Error description	Troubleshooting
E1	Abnormal communication: abnormal communication between up and down control and electronic meter.	Lower the control shutdown to the fault state. Unable to start. The electronic meter displays the error code and the buzzer rings 3 times. Possible causes: electronic control and electronic meter communication blocked, check the electronic meter to the lower control communication line for each section of the connection to ensure that each core is fully inserted. Check the connection between the electronic meter and the control unit for damage and replace the connection.
E2	Indicates that the regulator did not detect the voltage above the motor	Check that the motor lead is properly connected to the control terminal
E3	No speed sensor signal: the lower control has a voltage output to the DC motor and receives no motor speed feedback for more than 3 seconds continuously.	<p>1 Check if the motor cable is properly connected to the terminals on the controller</p> <p>2 Stop the machine and enter the error state, the electronic meter buzzer sounds 9 times and displays the error code at the same time, the rest of the area does not display the content. Keep the error state for about 10 seconds, then enter standby mode, can be restarted.</p> <p>Possible cause: The speed sensor signal is not detected for 3 seconds consecutively, check if the sensor connector is not connected correctly or damaged, connect it properly or replace the sensor.</p> <p>3 stops in the error state, the electronic meter buzzer sounded 9 times, while the error code was displayed, the rest of the area does not display the content. If normal is restored after stopping, it can enter standby mode and turn on normally</p>

E5	Over current protection: in operating mode, the DC motor current is continuously detected for more than 5 seconds.	Stop into the error state, electronic meter buzzer ring 9, at the same time display error code, the rest of the area does not display content. Keep error state about 10 seconds after entering standby mode, can restart. Possible causes: too high load leads to too high current, system self-protection or part of the treadmill is stuck, resulting in the motor not being able to turn, heavy load, too high current, system self-protection; Adjust the treadmill to restart it. The second is to check if the engine runs smoothly current noise or charred smell, to replace the engine; or to check if the control unit is charred smell, to replace control unit; or to check if the mains voltage specification is inconsistent or low, retest with the correct voltage specification.
E6	Explosion-proof coil protection: damage to the drive motor circuit caused by abnormal supply voltage or abnormal motor, etc.	Possible causes: Check if the mains voltage is lower than 50% of the normal voltage, use the correct voltage specification to retest; check if the control unit has a bad smell, replace the control unit; check if the motor cable is connected, reconnect the motor cable
E07	Indicates that the electronic meter does not detect as a security key signal	Magnetron damaged, magnetron installation position is correct, magnetron is positioned.

## 2. FAQs and exclusion methods

1. some or all keys don't work

1.1 Open the upper shell of the electronic watch and test whether the keys are normal.

1.2 Check or replace electronic clock panels.

1.3 If the button can be used normally after re-energizing.

2. Electronic display

### Exclusion Guidelines:

- 2.1 Check that the input voltage is within the permitted range.
- 2.2 Check that the power switch of the running machine is on.
- 2.3 Check that the fuse in the electrical outlet is fused. If it is blown, replace it with a spare fuse.
- 2.4 Check the controller to see if the LEDs are on.
- 2.5 Check the connection lines.
- 2.6 Inspection or replacement of electronic clock panels.
- 2.7 Check or replace the lower control circuit board.

### 3. Other matters and exceptions

#### a. The treadmill cannot start

Check that the power plug is connected, that the power switch is on and the safety switch is on is removed.

#### b. Treadmill cord

See the instructions and adjust the running belt.

#### c. Running belt

See the instructions and adjust the running belt in the middle.

#### d. Operating noise

Check that the machine screws are loose and that the running belt needs lubricating oil.

## Maintenance clauses

### 1. Scope of the warranty

Product in proper use and maintenance of normal use of non-human damage.

### 2. Free warranty period

Free warranty for one year from date of purchase. Vulnerable parts, normal wear and tear are not covered

with warranty, such as running belt and other accessories.

The following conditions are not covered by the warranty

- a. damage caused by misuse, negligent use, accident or unauthorized modification.
- b. damage caused by improper adjustment of running belt and drive belt.
- c. damage due to abnormal maintenance.
- d. other irregularities and consequent damage.





## Practice notes



- consult your doctor before starting a sports or exercise program, follow your doctor's advice and guidance.
- set exercise goals after consulting your doctor to ensure the plan is realistic and starts the training plan calmly.
- you can add some aerobic exercise to your exercise plan, such as walking, jogging, swimming, dancing or cycling. Always check your heart rate. If you do not have an electronic heart rate monitor, ask your doctor how to measure your heart rate by hand from your wrist or neck. Besides, you must set the target heart rate based on annual fitness and physical fitness.
- Drink plenty of water during exercise. You need to replenish the water lost through excessive exercise to prevent dehydration. Avoid drinking large amounts of ice water or drinks, drinking water or beverages at room temperature.

## Warm-up exercises

Warm-up and cool-down exercise: A successful exercise program must include warm-up, aerobic and calming exercise. Exercise at least two to three times a week, exercise one day off, a few months later you can increase the number of workouts to one Thursday to five days. Heating is a lot important part of your training. Warm up your body before each workout. Moderate heating can prepare your body for the next more intense workout, as warming up can help your muscles warm up and stretch, improve blood circulation, your heart rate and send more oxygen to your muscles.

After aerobic exercise, repeated warm-ups can also reduce muscle soreness. We recommend after warm-up and calming exercises.

<p>1. Stretch out: Bend your knees slightly, bend your body slowly forward, relax your back and shoulders and touch your toes as much as possible. Hold for 10-15 seconds and then relax. Repeat 3 times.</p>	 <p>Pic 1</p>
<p>2. Stretch: Sit on a clean cushion, straighten one leg, then close the other leg to the inside of a straight leg and touch the toes with your hands. Hold for 10-15 seconds and then relax. Repeat each leg three times.</p>	 <p>Pic 2</p>

<p>3. Tendon extension of leg and heel:</p> <p>Hold onto the wall or stand with both hands, one-foot behind, back leg straight, heel on the ground, lean against the wall. Hold for 10-15 seconds and then relax. Repeat 3 times for each leg.</p>	 <p>Pic 3</p>
<p>4. Quadriceps:</p> <p>Balance with your left hand on the wall or table, then reach your right hand back, grab your right heel and slowly pull your hip until you feel the muscles in front of your thighs tense. Hold for 10-15 seconds and then relax. Repeat each leg.</p>	 <p>Pic 4</p>
<p>5. Sartorius muscle (inner thigh muscle) extension:</p> <p>The soles of the feet were opposite, the knees were out, and both hands grabbed the feet and pulled the groin. Hold for 10-15 seconds and then relax. Repeat 3 times</p>	 <p>Pic 5</p>